



ATMP

All Terrain Mobility Platform

SPECIFICATION SHEET



The All Terrain Mobility Platform has now been in active service around the world for nearly four decades. It's unrivalled cross country performance and 'go anywhere' ethos combined with a class leading payload and adaptability for different roles continues to attract new users and drive design evolution.

The ATMP has provided the base platform for a wide variety of military, emergency response and civilian applications including drop zone clearance, troop support and re-supply, airfield logistics support, firefighting, maritime launch & recovery and electrical and mechanical engineering logistic support. It can be transported internally and underslung by current aviation assets, providing instant mobility support for air-mobile forces.

The latest versions of the base vehicle architecture add options for full electric and hybrid electric propulsion to complement the conventional diesel variant, with exportable power and 'optional manning' capabilities for increasing autonomy of 'dull, dangerous or dirty tasks'.

A	Length	3443 mm
B	Width	1935 mm
C	Height	1873 mm
D	Track	1547 mm
E	Wheelbase to Axle 2	923 mm
F	Wheelbase to Axle 3	1846 mm
G	Load Length	1460 mm
H	Load Height	929 mm
I	Ground Clearance	226 mm
J	Approach Angle	45°
K	Departure Angle	45°

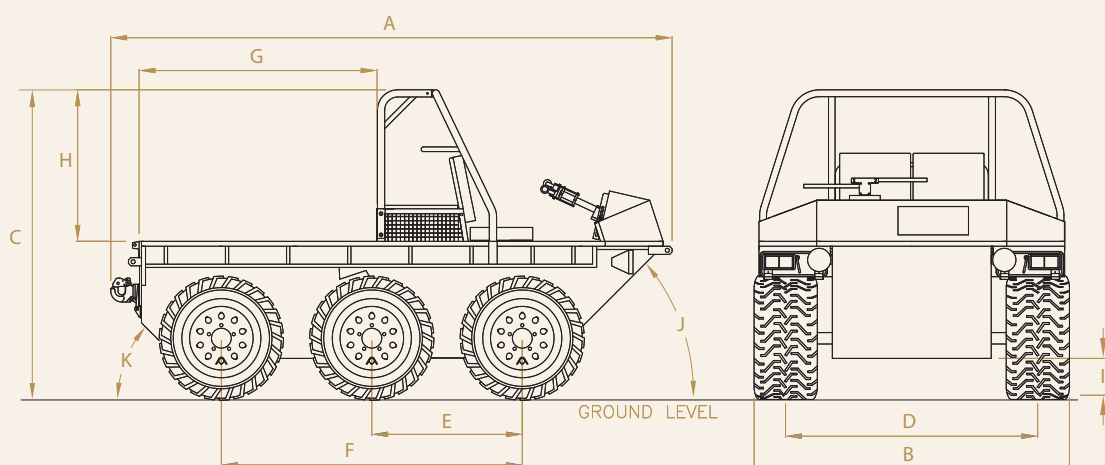

ATMP Vehicle Specification

Weight (GVW)	3500 kg
Payload*	1600 kg
Kerb weight*	1900 kg
Maximum speed*	60 km/h
Maximum road range*	850 km
Fording	600 mm
Gradient	45°
Side slope	40°
Propulsion options*	
- Diesel 1.9l Turbo diesel engine	
- Hybrid diesel/electric 1.5l Turbo diesel engine and generator	
- Fully electric powering individually controlled axle mounted electric motors	
Power	58 kW
Steering	Power assisted front four wheel steering plus skid steer
Brakes	Via axle mounted electric motors plus disc brakes on front 2 axles
Tyres	31/15.5 R15
Electrical system	84 Volt for propulsion plus 12/24V DC

Options (from new or upgrade)

Self recovery winch, remote weapons station, weapon mounts, smoke grenade launchers, IR lights, RHD or LHD, optionally manned functionality including terrain detection and response, obstacle clearance/avoidance, path planning and motion behaviour control

*depending on variant



ATMP configured for optional manning